



Fiber Solution

# NetWaySP8 Series

## 8-Port Ethernet over Fiber PoE+ Hardened Switches

### Models Include:

#### NetWaySP8WP

- Dual Fiber Optic SFP 1G Link, 8-port PoE+ switch and power supply.
- NEMA4/4X, IP66 rated Outdoor enclosure.

#### NetWaySP8WPX

- Dual Fiber Optic SFP 1G Link, 8-port PoE+ switch and power supply.
- NEMA4/4X, IP66 rated Outdoor enclosure.
- Accommodates up to four (4) 12VDC/4AH batteries.

#### NetWaySP8X

- Dual Fiber Optic SFP 1G Link, 8-port PoE+ switch and power supply.
- NEMA1 rated Indoor enclosure.

#### NetWaySP8WPN

- Dual Fiber Optic SFP 1G Link and 8-port PoE+ switch (uses external power supply).
- NEMA4/4X, IP66 rated Outdoor enclosure.

#### NetWaySP8PL

- Dual Fiber Optic SFP 1G Link, 8-port PoE+ switch and power supply.
- Backplane version.

#### NetWaySP8B

- Dual Optic SFP 1G Link and 8-port PoE+ switch
- Board only.

## Installation Guide



I.T.E. 43KC

DOC#: NetWaySP8 Rev. 032117



More than just power.™

Installing Company: \_\_\_\_\_ Service Rep. Name: \_\_\_\_\_

Address: \_\_\_\_\_ Phone #: \_\_\_\_\_

# Table of Contents:

Overview .....	pg. 3
Features .....	pg. 3
Mounting Instructions .....	pg. 4
Installation Instructions .....	pg. 4
Recommended Altronix SFP Modules .....	pg. 5
Technical Specifications .....	pg. 5
<b>Configuring Units for Network Connection</b> .....	<b>pg. 6</b>
Factory Default Settings .....	pg. 6
Network Settings .....	pg. 6
Static .....	pg. 6
DHCP .....	pg. 6
Secure Network Setup .....	pg. 7
Factory Reset Option .....	pg. 7
VLans .....	pg. 8
Vlan Setup Drawing .....	pg. 9
Typical Applications Drawings .....	pg. 10-11
Wall Mount Installation .....	pg. 12
Pole Mounting Using Optional Pole Mount Kit .....	pg. 12
Mechanical Drawings and Dimensions .....	pg. 13-16

## Overview:

Altronix NetWay Indoor/Outdoor Ethernet over Fiber PoE Hardened Switches provide two (2) 1Gb SFP ports and eight (8) PoE+ (30W) ports or up to two (2) Hi-PoE (60W) ports, passing data and power to PoE/PoE+ compliant devices. Cameras/edge devices may be located up to 100m from the unit. Features also include an integral battery charger for applications requiring backup and embedded LINQ Technology to monitor, control, and report power and diagnostics from anywhere.

## Features:

### Agency Listings:

- UL/cUL Listed for Information Technology Equipment (UL 60950-1), Information Technology Equipment to Be Installed Outdoors (UL 60950-22).
- CE European Conformity.

### Input:

- 115VAC, 60Hz, 2.5A or 230VAC, 50/60Hz, 1.3A.
- NetWaySP8B/NetWaySP8WPN:**  
48-56V UL Listed ITE power supply (up to 120W)

### Power Output:

- Eight (8) ports PoE+ (30W) or up to two (2) Hi-PoE (60W) ports.
- IEEE 802.3at (30W) and IEEE 802.3af (15W) compliant.
- 115W total power.
- Integral surge protection.

### Fiber Port:

- Two (2) Gigabit SFP ports.
- Use with SFP module 1000Base-X (1Gb), compliant to Class 1 laser product (not included).

### Ethernet Ports:

- Six (6) 10/100 Mbps and two (2) 10/100/1000 Mbps ports.
- Connectivity: RJ45, auto-crossover.
- Wire type: 4-pair CAT5 or better structured cable.
- Distance: up to 100m.
- Speed: 10/100/1000 Mbps, half/full duplex, auto negotiation.

### Battery Backup:

- Built-in charger for sealed lead acid or gel type batteries.
- Battery charging circuit: 48VDC, 300mA.
- Automatic switch over to stand-by battery when AC fails.

### LEDs:

- Individual **PoE On** LEDs for each port.
- Individual **IP Link status, 10/100Base-T/active** LEDs for each port.
- **ALOS** LED indicates fiber connection for SFP port.
- **Heartbeat** LED indicates proper operation of the unit.

### Environmental:

- Refer to Technical Specifications Chart on page 4 for Environmental Conditions.

### Applications:

- Provides PoE / PoE+ / Hi-PoE for cameras/devices.

### VLAN:

- Multiple management VLAN assignment.
- 802.1Q Tagged VLAN.
- Up to 10 VLAN groups. ID Range 2-4095.

### LINQ Technology:

- Remote network management allows for camera/device reset and monitoring.
- Provides local and/or remote access to critical information via LAN/WAN.
- Email and Windows Dashboard Alert notifications report real-time diagnostics.
- Event log tracks history.

### Accessories:

#### NetWaySP1A

- Ethernet over Fiber Media Converter/Repeater for applications requiring an additional SFP (Fiber) port

### Mechanical:

#### NetWaySP8WP

- NEMA4/4X, IP66 Rated enclosure for outdoor use.
- Dimensions (H x W x D approx.):  
13.31" x 11.31" x 5.59"  
(338.1mm x 287.3mm x 142mm).

#### NetWaySP8WPN

- NEMA4/4X, IP66 Rated enclosure for outdoor use.
- Dimensions (H x W x D approx.):  
13.31" x 11.31" x 5.59"  
(338.1mm x 287.3mm x 142mm).

#### NetWaySP8WPX

- NEMA4/4X, IP66 Rated enclosure for outdoor use.
- Accommodates four (4) 12VDC/4AH batteries (48V of backup).
- Dimensions (H x W x D approx.):  
17.375" x 12" x 6.5"  
(441.3mm x 304.8mm x 165.1mm).

#### NetWaySP8X

- Dimensions (H x W x D approx.):  
13.5" x 13" x 3.25" (342.9mm x 330.2mm x 83mm).

#### NetWaySP8PL

- Dimensions (H x W x D approx.):  
10.75" x 8.875" x 2.375"  
(273.1mm x 225.4mm x 60.3mm).

#### NetWaySP8B

- Dimensions (L x W x D approx.):  
5.625" x 4.5" x 0.625"  
(158.8mm x 142.9mm x 15.9mm).

## Enclosure/Board/Backplane Mounting Instructions:

Wiring methods shall be in accordance with the National Electrical Code/NFPA 70/ANSI, and with all local codes and authorities having jurisdiction. All units should be installed by a trained service personnel.

### NetWaySP8WP/8WPN/8WPX Enclosure Mounting and Installation:

1. Remove backplane from enclosure prior to drilling. Do not discard hardware.

**Note:** Make sure that hardware will not interfere with components of the circuit board.

2. Mark and drill desired inlets on the enclosure to facilitate wiring. Maximum NEMA type 4X rated fittings to be used are 0.5". Follow manufacturer's specifications for the appropriate size opening.

**Note:** Inlets for conduit fittings should only be made on the bottom of the enclosure.

UL Listed NEMA type 4X rated conduit connector/hubs shall be used for the appropriate size inlets.

3. Clean out the inside of enclosure before remounting circuit board.

4. Mounting NEMA4/4X rated enclosure (*Enclosure Dimensions, pgs. 13-16*):

**Wall mount:** Mount unit in desired location. Mark and drill holes to line up with the top and bottom holes of the enclosure flange. Secure enclosure with appropriate fasteners (e. g. screws and anchors; bolts and locking nuts, etc.) that are compatible with mounting surface and are of sufficient length/construction to ensure a secure mount (*Fig. 7, pg. 12*).

**Pole Mount:** Refer to *Figs. 8 - 13, pg. 12*.

5. Mount backplane in enclosure with hardware.

6. To facilitate wire entry utilize weather-tight NEMA rated connectors (*supplied*), bushings, and cable.

### NetWaySP8X Enclosure Mounting and Installation:

1. Mount unit in the desired location. Mark and predrill holes in the wall to line up with the top two keyholes in the enclosure. Install two (2) upper fasteners and screws in the wall with the screw heads protruding. Place the enclosure's upper keyholes over the two (2) upper screws; level and secure. Mark the position of the lower two (2) holes. Remove the enclosure. Drill the lower holes and install two fasteners. Place the enclosure's upper keyholes over the two (2) upper screws. Install the two (2) lower screws and make sure to tighten all screws (*Enclosure Dimensions, pg. 12*). Secure enclosure to earth ground.

### NetWaySP8B/8PL Mounting and Installation:

1. Mount board/backplane in the desired location/enclosure with hardware supplied (*Fig. 1, pg. 4*).

2. **NetWaySP8B:** Connect 56VDC/120W max power source to terminal marked [+ ] and [-].

**Note:** For proper earth ground connections on NetWaySP8B fasten metal spacers (provided) to threaded studs at indicated board mounting holes (*shown on the right*). This is recommended for better environmental immunity.

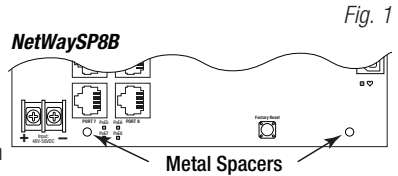

Fig. 1

## Installation Instructions:

1. For NetWaySP8WP/8WPX/8X/8PL: Before powering unit, set input voltage selection switch to proper Input Voltage position (*Fig. 5a, pg. 10*). Units are factory set for 115VAC.

2. Secure cabinet to earth ground. Connect AC power from overcurrent protective device circuit breaker (20A @ 115VAC, 60Hz, 16A @ 230VAC, 50/60Hz) to the terminals marked [L, N] on power supply board (*Fig. 5, pg. 10*). Use 14AWG or larger for all power connections (Battery, DC output, AC input). Connect ground lug ⊕ to earth or green branch wire (12AWG min.).

**Note:** For NetWaySP8WPN use external 48-56V UL Listed ITE power supply, carefully observing correct polarity (*Fig. 5, pg. 10*). Keep power-limited wiring separate from non power-limited wiring by utilizing separate knockouts/inlets. Minimum 0.25" spacing must be provided.

**CAUTION:** Do not touch exposed metal parts. Shut branch circuit power before installing or servicing equipment. There are no user serviceable parts inside. Refer installation and servicing to qualified service personnel.

### 3. Port Configurations (Fig. 2, pg. 5; Fig. 5b, pg. 10):

Jumper	Jumper Position	Structured Cable Ports							
		1	2	3	4	5	6	7	8
PORT 4	30W	30W and Data				-			
PORT 6	30W	-				30W and Data			
PORT 4	60W	Data Only		60W and Data		-			
PORT 6	60W	-				Data Only	60W and Data	Data Only	

Fig. 2

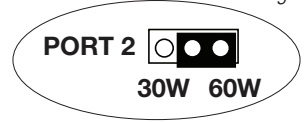

- Connect structured cables from port marked [Port 1] to [Port 8] on NetWay unit to PoE-compliant cameras/ edge devices (Fig. 5, pg. 10).  
**Note:** All interconnected devices must be UL Listed.
- Insert SFP module into port(s) marked [SFP], then connect cable to the SFP module on NetWaySP8B to the corresponding input of an SFP switch (Fig. 5, pg. 10).
- Battery Backup** (if desired): Connect four (4) 12VDC batteries wired in series to terminals marked [- BAT +] (Fig. 5, pg. 10), carefully observing polarity.  
When use of stand-by batteries is desired, they must be lead acid or gel type.  
**Note:** When batteries are not used, a loss of AC will result in the loss of output voltage.
- Please ensure that the cover is secured with:  
Key lock and screws for **NetWaySP8X**, security bolt for **NetWaySP8WP/8WPN/8WPX**.

### Recommended Altronix SFP Modules:

- P1MM** - For use with Multi-Mode Fiber for distances up to 550m.
- P1SM10** - For use with Single-Mode Fiber for distances up to 10km.
- P1AB2K** - For use with Single-Mode Single Strand Fiber for distances 2km.
- P1GCE** - For use with CAT5e or better copper ethernet for distances up to 100m.

### Technical Specifications:

Parameter	Description		
<b>Number of Ports</b>	Eight (8) ports PoE+ (30W) or up to two (2) Hi-PoE (60W) ports. Two (2) Gigabit SFP Ports.		
<b>Input Power Requirements</b>	115VAC, 60Hz, 2.5A or 230VAC, 50/60Hz, 1.3A. <b>NetWaySP8B/8WPN:</b> 48-56V UL Listed ITE power supply		
<b>Environmental Conditions</b>	Operating Ambient Temperature: <b>NetWaySP8WP/8WPX:</b> <b>60W:</b> - 40°C to 75°C (- 40°F to 167°F); <b>75W:</b> - 40°C to 70°C (- 40°F to 158°F); <b>100W:</b> - 40°C to 55°C (- 40°F to 131°F); <b>115W:</b> - 40°C to 45°C (- 40°F to 113°F). <b>NetWaySP8X:</b> <b>115W:</b> - 40°C to 50°C (- 40°F to 122°F). <b>NetWaySP8B/8WPN:</b> <b>115W:</b> - 40°C to 75°C (- 40°F to 167°F). Relative Humidity: 85%, +/- 5% Storage Temperature: - 40°C to 85°C (- 40°F to 185°F). Operating Altitude: - 304.8 to 2,000m.		
<b>Weights (approx.)</b>	<b>Model</b>	<b>Product Weight</b>	<b>Shipping Weight</b>
	NetWaySP8WP	10.72 lbs. (4.86 kg)	12.1 lbs. (5.49 kg)
	NetWaySP8WPN	7.9 lbs. (3.58 kg)	10.2 lbs. (4.63 kg)
	NetWaySP8WPX	15 lbs. (6.8 kg)	17.5 lbs. (7.9kg)
	NetWaySP8X	6.85 lbs. (3.11 kg)	7.75 lbs. (3.51 kg)
	NetWaySP8PL	2.8 lbs. (1.27 kg)	4.2 lbs. (1.9 kg)
NetWaySP8B	0.45 lbs. (0.2 kg)	1 lbs. (0.45 kg)	

# Configuring Units for Network Connection

Please be sure to visit [altronix.com](http://altronix.com) for latest firmware and installation instructions

## Factory Default Settings

- IP Address: 192.168.168.168
- User Name: admin
- Password: admin

1. Set the static IP address for the laptop to be used for programming to the same network IP address as the NetwaySP8. The default address of the NetwaySP8 is 192.168.168.168, E.I. 192.168.168.200.
2. Connect one end of the network cable to the network jack on the NetwaySP8 and the other to the network connection of the laptop.
3. Open a browser on the computer and enter "192.168.168.168" into the address bar.  
A dialog box Authentication Required will appear requesting both user name and password.  
Enter the default values here. Click on the button labeled **Log In**.
4. The status page of the NetWaySP8 will appear. Click on the tab labeled **Network Settings**.  
This will open the Network Setting screen. In this screen the MAC Address of the NetWaySP8 module will be found along with the Network Settings and Email Settings.

## Network Settings:

In the IP Address Method field select the method that the IP Address for the NetWaySP8 will be obtained (STATIC or DHCP), then follow the appropriate steps.

### Static:

1. IP Address: Enter the IP address assigned to the NetWaySP8 by the network administrator.
2. Subnet Mask: Enter the Subnet of the network.
3. Gateway: Enter the TCP/IP gateway of the network access point (router) being used.  
Gateway configuration is required to properly receive emails from the device.
4. HTTP Port: Enter the HTTP port number assigned to the NetWaySP8 module by the network administrator to allow remote access and monitoring. The default inbound port setting is 80. HTTP is not encrypted and unsecure. Even though HTTP can be used for remote access, it is recommended primarily for use with LAN connections.
5. HTTPS Port: Enter the HTTPS port number assigned to the NetWaySP8 module by the network administrator to allow remote access and monitoring. The default inbound port setting is 443.  
Being encrypted and more secure, HTTPS is highly recommended for remote access.
6. Click the button labeled **Submit Network Settings**.  
A dialog box will display "New network settings will take effect after the server is rebooted". Click **OK**.

### DHCP:

1. After selecting DHCP in the IP Address Method field click the button labeled **Submit Network Settings**.  
A dialog box will display "New network settings will take effect after the server is rebooted". Click **OK**.  
Next, click on the button labeled **Reboot Server**. After rebooting the NetWaySP8 will be set in the DHCP mode. The IP address will be assigned by the router when the NetWaySP8 is connected to the network.  
It is recommended to have the assigned IP Address reserved to ensure continued access (see the network administrator).
2. Subnet Mask: When operating in DHCP, the router will assign the subnet mask values.
3. Gateway: Enter the TCP/IP gateway of the network access point (router) being used.
4. HTTP Port: Enter the HTTP port number assigned to the NetWaySP8 module by the network administrator to allow remote access and monitoring. The default inbound port setting is 80. HTTP is not encrypted and unsecure. Even though HTTP can be used for remote access, it is recommended primarily for use with LAN connections.
5. HTTPS Port: Enter the HTTPS port number assigned to the NetWaySP8 module by the network administrator to allow remote access and monitoring. The default inbound port setting is 443.  
Being encrypted and more secure, HTTPS is highly recommended for remote access.
6. Click the button labeled **Submit Network Settings**.  
A dialog box will display "New network settings will take effect after the server is rebooted". Click **OK**.

## Secure Network Setup (HTTPS):

In order to setup HTTPS for a Secure Network Connection, a Valid Certificate and Key must be used. Certificates and Key should be in a “.PEM” format. Self Certifications should only be used for testing purposes as no actual authentication is being performed. In a Self-Certified mode, the connection will still state that it is unsecure. How to upload Certificate and Key to setup HTTPS:

1. Open Tab Labeled “Security”
2. Select Tab Labeled “Email/SSL”
3. Scroll to bottom under “SSL Settings”
4. Click “Select Certificate”
5. Browse and select valid Certificate to upload from server
6. Click “Select Key”
7. Browse and select valid Key to upload from server
8. Click “Submit Files”

Once the Certificate and Key is uploaded successfully you can proceed with setting up HTTPS in Network Settings.

- A. HTTPS Port: Enter the HTTPS port number assigned to the NetWay Spectrum module by the network administrator to allow remote access and monitoring. The default inbound port setting is 443. Being encrypted and more secure, HTTPS is highly recommended for remote access.
- B. Click the button labeled **Submit Network Settings**.  
A dialog box will display “New network settings will take effect after the server is rebooted”. Click **OK**.

## Factory Reset Option:

1. Power the unit down. Allow approximately 30 seconds for the unit to power down completely.
2. Depress Factory Reset button on NetWaySP8B while reapplying power to the unit (*Fig. 3, pg. 7; Fig. 5c, pg. 10*). Continue holding the button until the LEDs on board go through the start up cycle, then release the button.
3. The unit returns to the original factory settings.

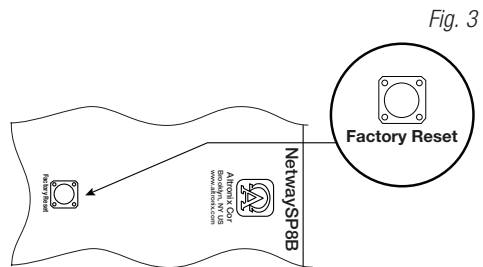

## VLANs

VLANs (Virtual Local Area Networks) are a subnetwork that allow for the grouping together of devices for improved network traffic as well as providing higher security by allowing greater control over which devices have access to each other. It is important to plan how you will setup your devices for each VLAN.

### Configuring vLan on the Altronix NetwaySP8 Series Switch:

1. Ensure Laptop or PC being used to program the vLan settings is on a port that will be assigned to your first vLan configuration. By default the management portion of the software is assigned to vLan-1.  
**CAUTION:** Changing VID=1, the industry standard VLAN HOST address to any other VID address should be done with caution and performed only locally, since the change will drop the original HOST connection. Local access then facilitates a physical reconnection to respective port.  
**Note:** Only this vLan network allows access to IP management.
2. In Network Section click on vLan Tab.
3. Click Add vLan.
4. Enter a name for the vLan.
5. Enter a vLan ID, i.e. 10, 20, etc. Ensure this vLan ID is associated with a vLan setup on the main switch and that your Laptop or PC being used for programming is on this same ID  
**Note:** vLan ID could be any value 2-4094.
6. Assign vLan QOS (Quality of Service) priority. 0 = Lowest and 7 = Highest
7. Pick a Trunk port (Tagged Ports). Trunk ports are typically the main connection for network traffic for each group. They are usually connected to a network switch, WAPs, etc.
8. Pick the Access port(s) (Untagged Ports) associated with the vLan. Access Ports are typically used for Cameras, etc. If programming locally, ensure your laptop or PC is connected to one of these ports.
9. Save Configuration.
10. Repeat steps 2 - 9 to add another vLan
11. **Advanced Port Settings:**  
If unit is accidentally programmed incorrectly and you cannot get into the NetwaySP8 series programming, physically moving ports of your PC connected to the main switch to a correct port (when being programmed remotely), or, as a last resort, completing a factory reset locally and reprogramming the unit.  
Unknown VID Packet Forwarding Configuration:  
On ingress unknown VID, Forward to a fixed set of ports. By default no forwarding is set.  
Configuration on Ingress Untagged Traffic:  
Trunk Port action for ingress UNTAGGED packets. By default do not drop packets.  
Keep Tag on Egress:  
Select if you want ACCESS Port to keep the vLan tag when sending egress packets.  
By default tags are stripped.  
Preferred VLAN Forwarding:  
For ACCESS Ports that belong to more than one VLAN. Select preferred vLan to forward UNTAGGED ingress packets. By default preferred vLan is the last vLan created.



Fig. 4

## Typical VLAN Setup:

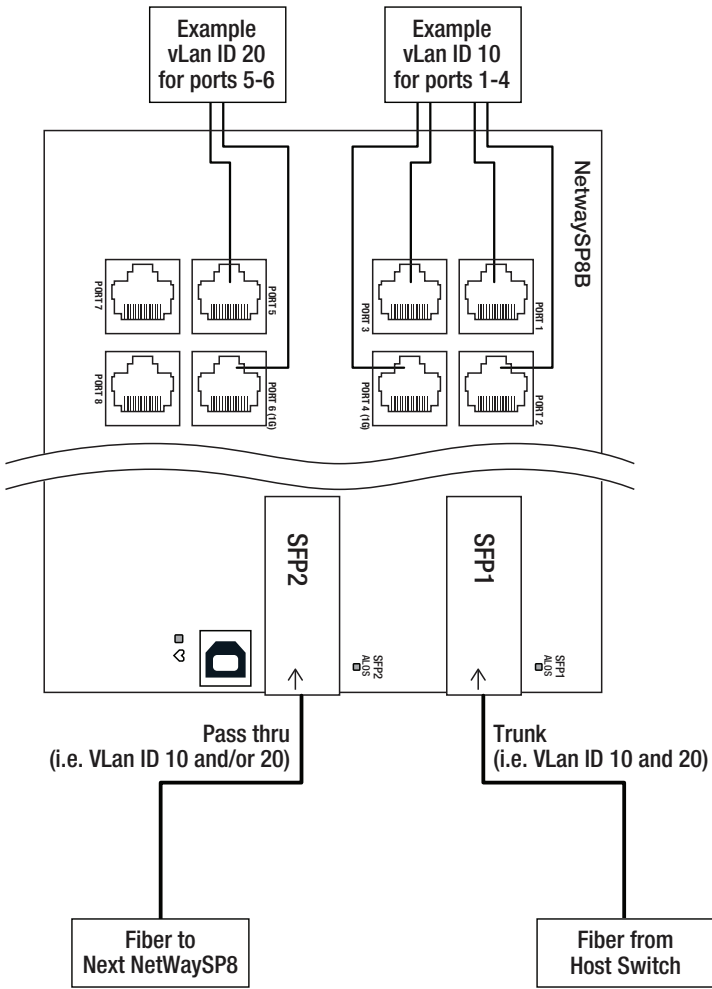

# Typical Applications:

Fig.5

## NetWaySP8X - Power Supply Board Orientation

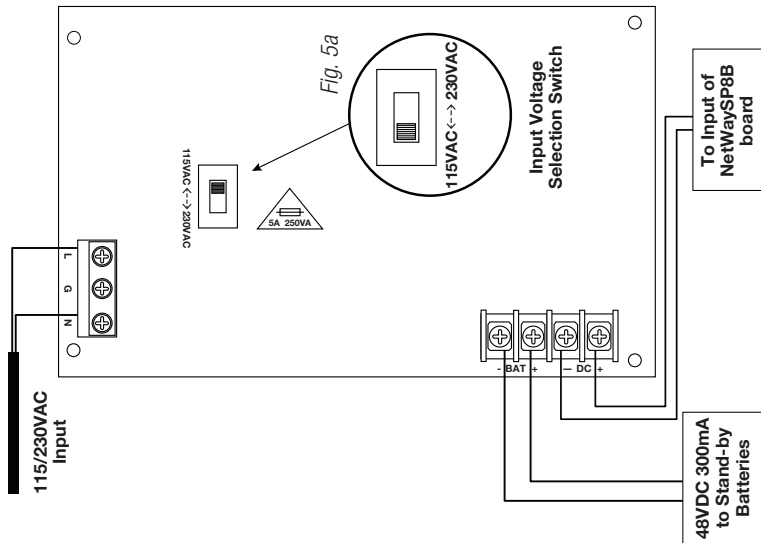

## NetWaySP8WP and NetWaySP8WPX Power Supply Board Orientation

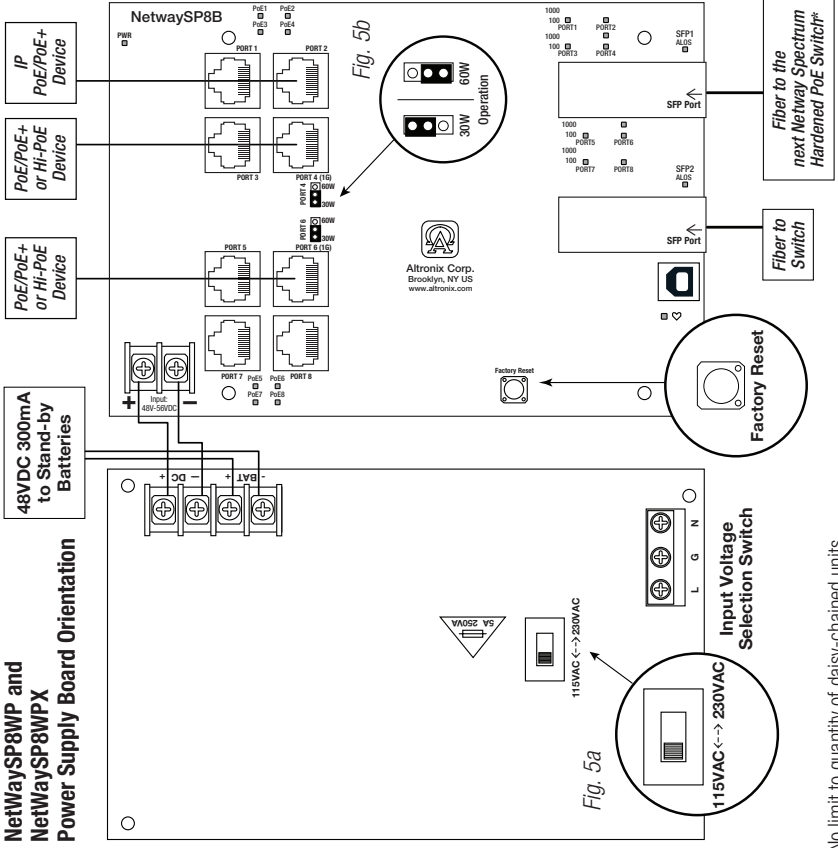

\*Note: No limit to quantity of daisy-chained units. Daisy chaining only limited to total bandwidth of 1Gbps.

Fig. 6 - NetWaySP8WPN – Typical Application with Composite Cable

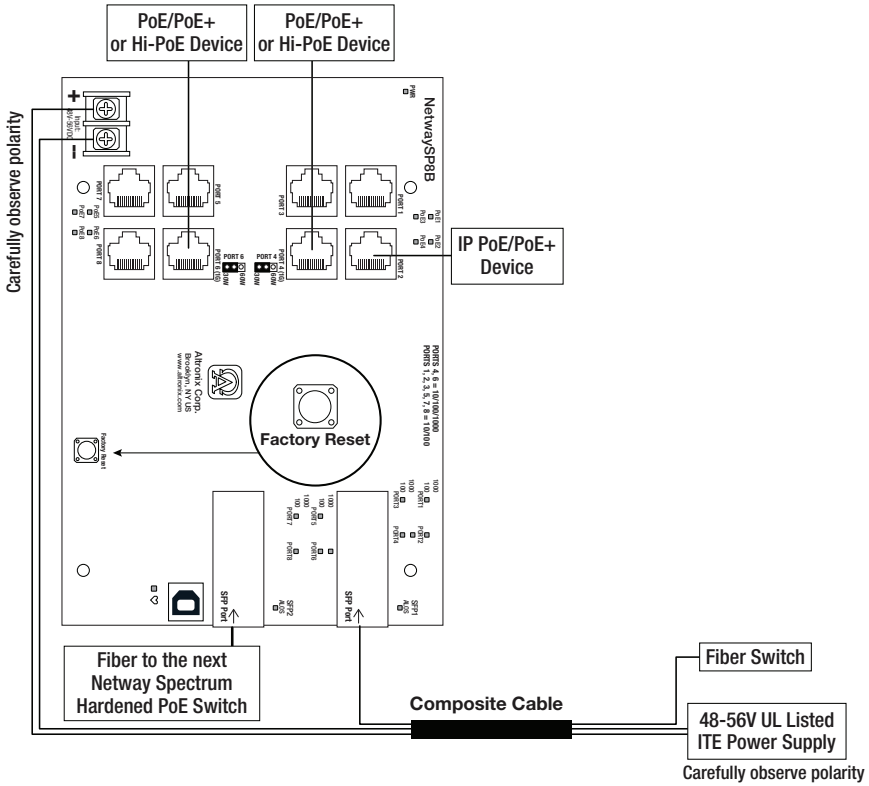

### Power Distance Chart

Power Requirements	Power Cabling	Maximum Distance (ft./m)
15W	12/2	11,162' / 3403m
30W	12/2	5,581' / 1702m
45W	12/2	3,767' / 1,148m
60W	12/2	2,739' / 835m
75W	12/2	2,249' / 686m
90W	12/2	1,872' / 571m
105W	12/2	1,607' / 490m
120W	12/2	1,408' / 429m
15W	16/2	4,415' / 1,346m
30W	16/2	2,207' / 673m
45W	16/2	1,490' / 454m
60W	16/2	1,083' / 330m
75W	16/2	889' / 271m
90W	16/2	740' / 226m
105W	16/2	635' / 194m
120W	16/2	557' / 170m

Estimated distances based on starting voltage of 56VDC and accounts for a 10 volt drop. All distances are per IEEE 802.3at standard for device power requirements of minimum 44VDC and leave an approximate 2 volts for safety and flexibility.

## Wall Mount Installation

1. Place unit at desired location and secure with mounting screws (not included) (Fig. 7, pg. 12).

Fig. 7

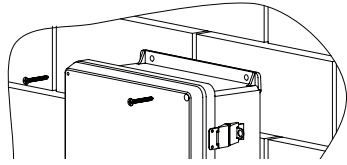

## Pole Mounting Using Optional Pole Mount Kit PMK1 (NetWaySP8WP/8WPN) or PMK2 (NetWaySP8WPX):

This installation should be made by qualified service personnel. This product contains no serviceable parts. PMK1 and PMK2 are intended for use with Altronix outdoor rated power supplies or accessories housed in WP1, WP2, WP3 and WP4 enclosures. Brackets are designed for use with the Wormgear Quick Release Straps (two included).

1. Thread one (1) wormgear quick release strap through the slots on the back of a mounting bracket (Fig. 8, pg. 12).
2. Once the desired height of the top Pole Mount bracket is achieved, tighten the straps down by sliding open end of the strap through the locking mechanism on the strap, then tighten the screw with flat head screwdriver or 5/16" hex socket driver (Fig. 9, pg. 8 and Fig. 11, pg. 12).

Fig. 8

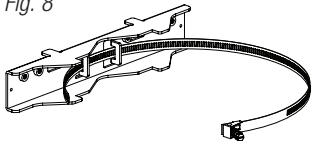

Fig. 9

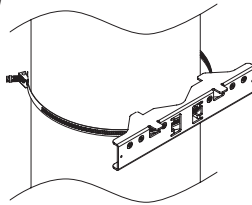
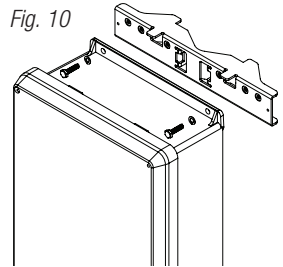

Fig. 10



3. Attach the bottom bracket to the enclosure by inserting bolts through the flange of the enclosure and into the bracket, tightening bolts with a 7/16" hex socket (Fig. 9, pg. 12).
4. Thread the second wormgear quick release strap through the slots on the back of the bottom mounting bracket (Fig. 8, pg. 12).
5. Mount enclosure onto the top bracket by inserting bolts through flange of the enclosure and into the bracket, tightening bolts with a 7/16" hex socket (Fig. 10, pg. 12).
6. Tighten the straps of the bottom bracket down by sliding the open end of the strap through the locking mechanism on the strap, then tighten screw with flat head screwdriver or 5/16" hex socket driver (Fig. 9, pg. 12).
7. Clip excess straps.

Fig. 11

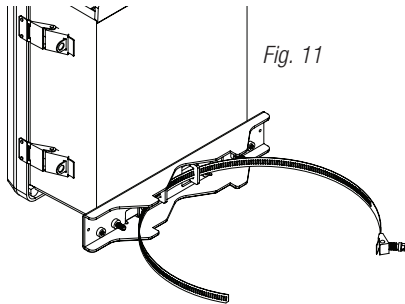

Fig. 12  
2" to 8" (50.8mm to 203.2mm)  
diameter round pole

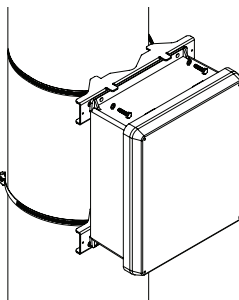
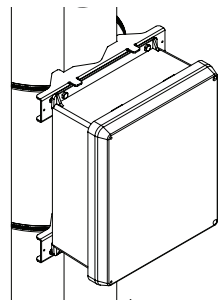

Fig. 12a  
5" (127mm) square pole



# NetWaySP8X

## Mechanical Drawing and Dimensions (H x W x D approx.):

13.5" x 13" x 3.25" (342.9mm x 330.2mm x 82.6mm)

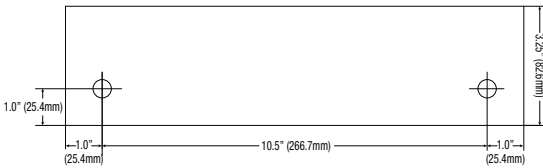
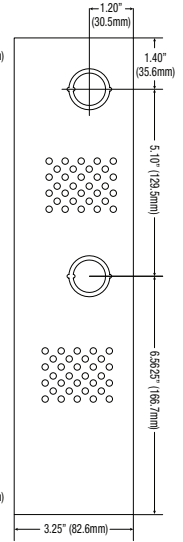
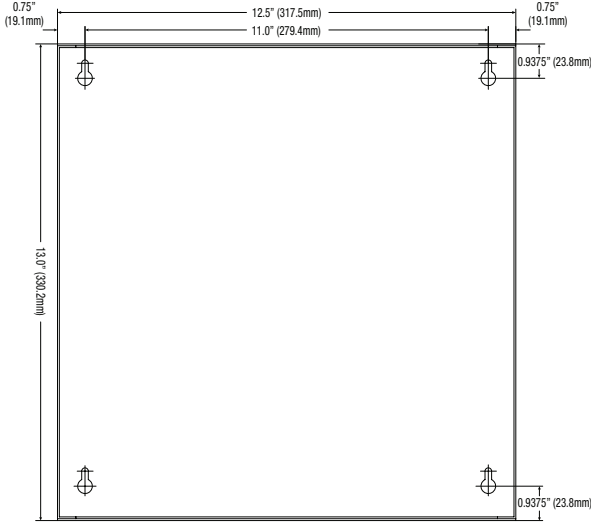
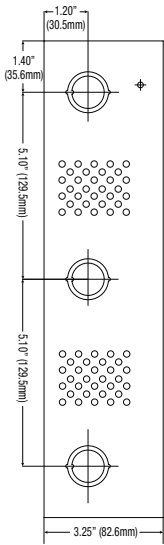
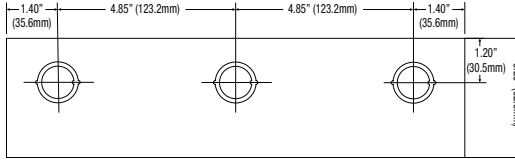

# NetWaySP8PL

## Mechanical Drawing and Dimensions (H x W x D approx.):

10.75" x 8.875" x 2.375" (273.1mm x 225.4mm x 60.3mm)

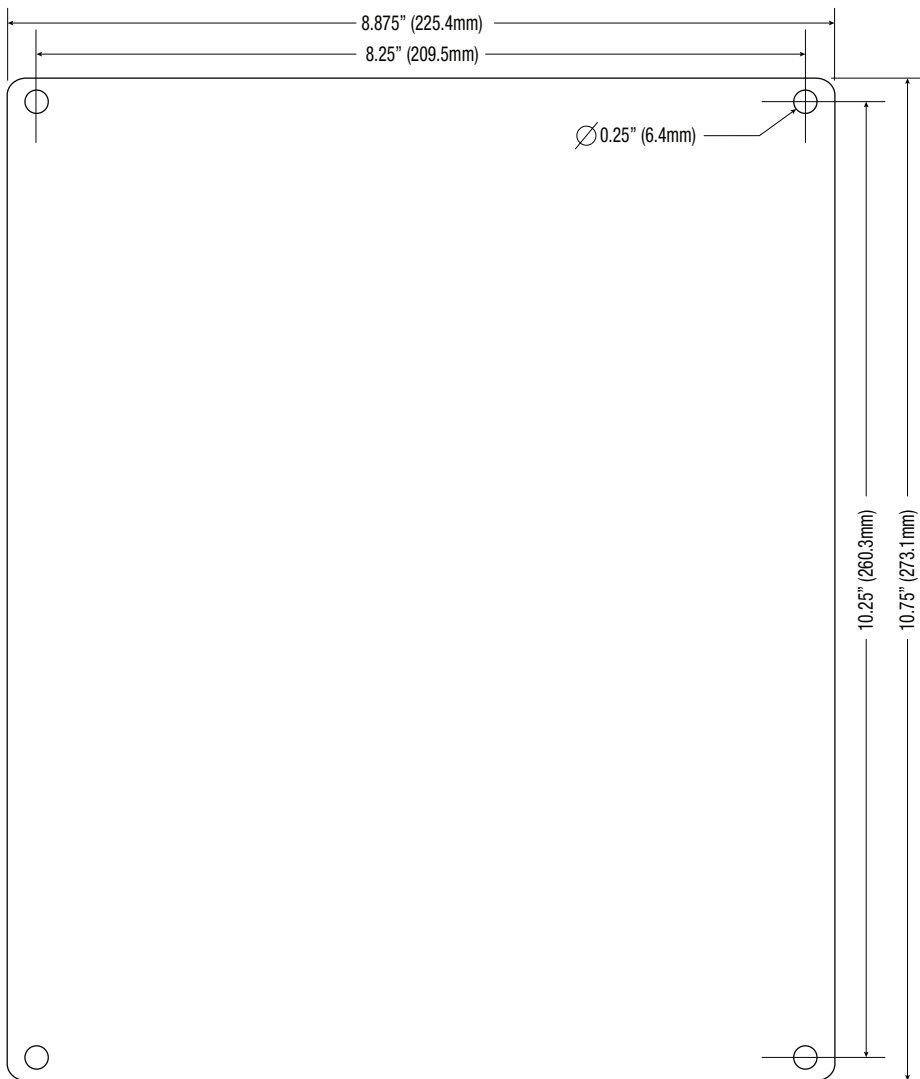

# NetWaySP8WP and NetWaySP8WPN Mechanical Drawing and Dimensions (H x W x D approx.):

13.31" x 11.31" x 5.59" (338.1mm x 287.3mm x 142mm)

**FRONT VIEW**

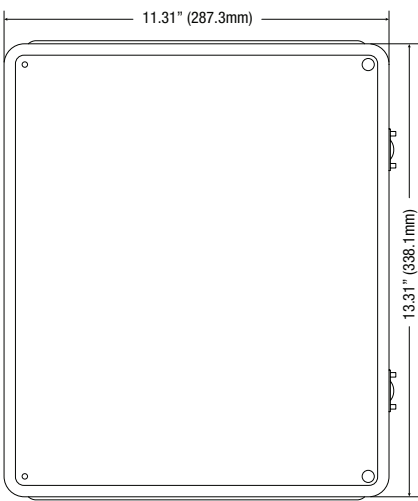

**RIGHT SIDE VIEW**

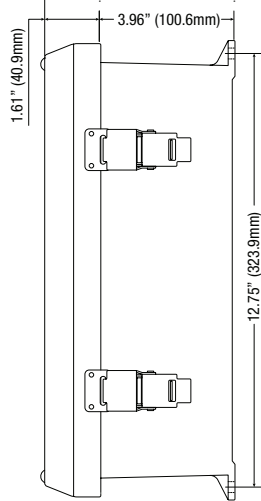

**FRONT VIEW COVER REMOVED**

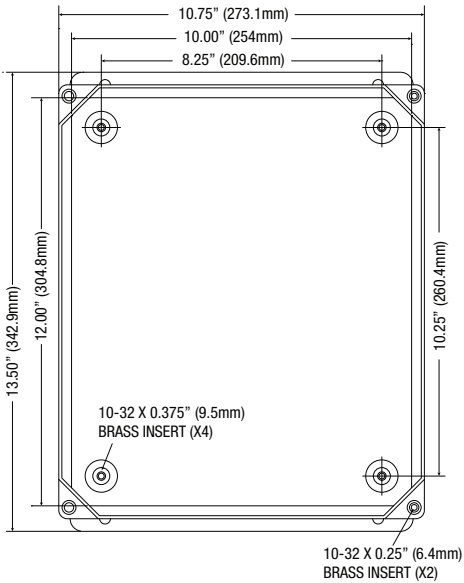

**END VIEW**

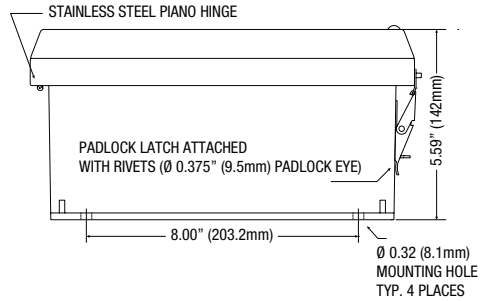

# NetWaySP84WPX

## Mechanical Drawing and Dimensions (H x W x D approx.):

17.53" x 15.3" x 6.67" (445.3mm x 388.6mm x 169.4mm)

**FRONT VIEW**

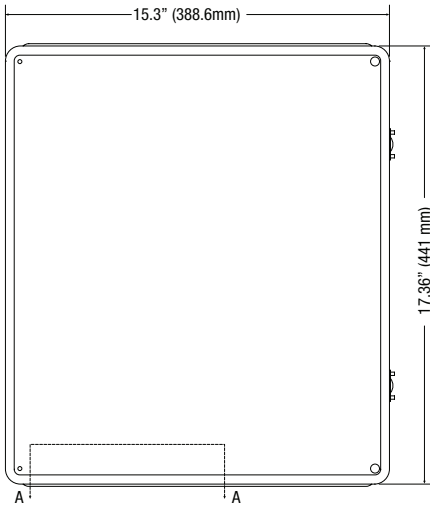

**RIGHT SIDE VIEW**

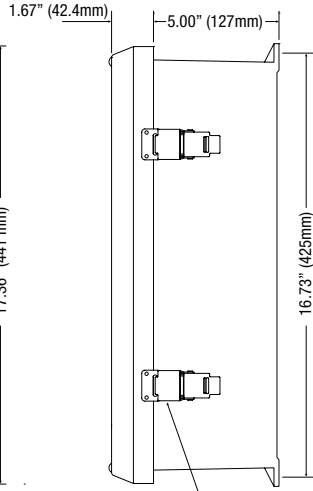

316 STAINLESS STEEL PADLOCK LATCH  
ATTACHED WITH RIVETS. Ø 0.375 PADLOCK EYE

**FRONT VIEW COVER REMOVED**

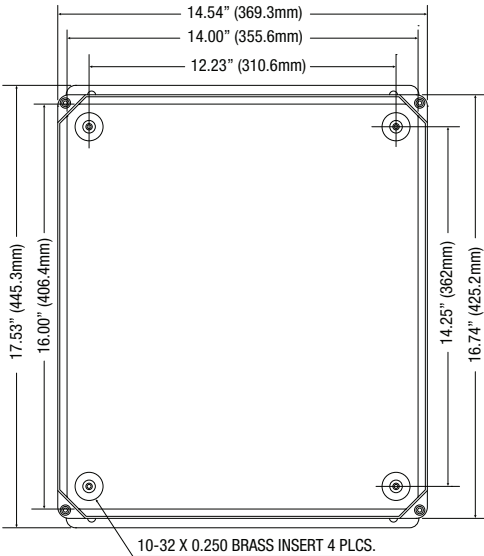

**SECTION A-A**

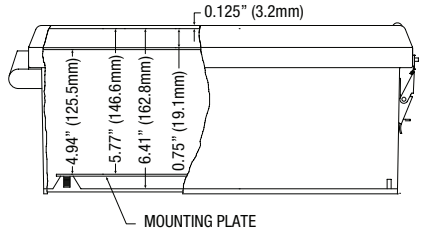

**END VIEW**

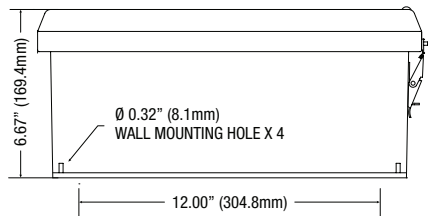

Altronix is not responsible for any typographical errors.

140 58th Street, Brooklyn, New York 11220 USA | phone: 718-567-8181 | fax: 718-567-9056  
 website: www.altronix.com | e-mail: info@altronix.com | Lifetime Warranty  
 IINetWaySP8 Series H27U

NetWaySP8 Series Installation Guide

